

LEVELS 66, 68, AND DPS 8  
MSU0500/0501 MASS STORAGE  
UNIT OPERATION

**SUBJECT**

General Description, Operation, and Maintenance Procedures for the MSU0500 and MSU0501 Mass Storage Units and Their Associated Mass Storage Processors

**SPECIAL INSTRUCTIONS**

This edition completely supersedes Revision 0 dated August 1977. It reflects the inclusion of the MSU0501 Mass Storage Unit and the associated Mass Storage Processors. Due to the extent of the revision, change bars and asterisks (denoting deletions) have not been used.

**ORDER NUMBER**

AY03, Rev. 1

December 1979

**Honeywell**

## ***Preface***

This reference manual contains performance specifications, and a description of the operator-accessible control panel switches and indicators and the operating procedures necessary to enable personnel to operate and maintain the MSU0500/0501. Mass storage processor information is also included.

# Contents

<p>Introduction . . . . . 1</p> <p>    MSU0500 Overview. . . . . 1</p> <p>    MSU0501 Overview. . . . . 2</p> <p>MSU0500/0501 Characteristics. . . . . 3</p> <p>    Advanced Data Integrity . . . . . 3</p> <p>    Efficient I/O Channel Utilization . . . . . 3</p> <p>    System Reliability/Availability . . . . . 3</p> <p>    Site Efficiency. . . . . 3</p> <p>    Options . . . . . 4</p> <p>Controls and Indicators. . . . . 4</p> <p>    Device Numbering. . . . . 4</p> <p>Operating Procedures . . . . . 5</p> <p>    Power-Up Sequence. . . . . 5</p> <p>    Power-Down Sequence . . . . . 5</p> <p>    Initialization . . . . . 5</p> <p>    Startup Sequence . . . . . 6</p> <p>Operator Maintenance. . . . . 6</p> <p>    General Cleaning. . . . . 6</p> <p>Mass Storage Processors. . . . . 6</p> <p>    Components . . . . . 6</p> <p>    Options . . . . . 7</p> <p>    MSP0602/0603/0605 . . . . . 8</p> <p>        MSU0500/0501 Attachment. . . . . 8</p> <p>    MSP0604/0607/0608/0609. . . . . 11</p> <p>    MSP8000/8001 . . . . . 13</p> <p>    Controls and Indicators. . . . . 13</p>	<p>3</p> <p>4</p> <p>5</p> <p>6</p> <p>7</p> <p>8</p> <p>9</p> <p>10</p> <p>11</p> <p>12</p> <p>1</p> <p>2</p> <p>3</p> <p>4</p> <p>5</p> <p>6</p>	<p>Mass Storage Processor</p> <p>    Components . . . . . 6</p> <p>MSP0602/0603 Single-Channel</p> <p>    Configurations. . . . . 9</p> <p>MSP0602/0603 Dual-Channel</p> <p>    Configurations. . . . . 10</p> <p>MSP0605 Configurations. . . . . 11</p> <p>MSP0604/0607 Configuration. . . . . 12</p> <p>MSP0608/0609 Configuration. . . . . 13</p> <p>MSP8000 Configurations. . . . . 14</p> <p>MSP8001 Configurations. . . . . 15</p> <p>Freestanding Mass Storage</p> <p>    Processor Control Panel. . . . . 15</p> <p>Integrated Mass Storage</p> <p>    Processor Control Panel. . . . . 16</p>
--	--	--

## Tables

### Figures

1	MSU0500/0501 Mass Storage Unit. . . . .	1
2	MSU0500/0501 Spindle Control Panel. . . . .	4

	Mass Storage Unit Characteristics . . .	2
	Subsystem Capacities . . . . .	3
	MSU0500/0501 Options. . . . .	4
	MSU0500/0501 Controls and Indicators . . . . .	5
	Mass Storage Processor Options. . . . .	7
	Mass Storage Processor Controls and Indicators. . . . .	16

## INTRODUCTION

The MSU0500 and MSU0501 Mass Storage Units are dual-spindle, nonremovable disk devices with large capacity and high throughput. Salient features of each device are described below. Table 1 presents the characteristics in an easy-to-read format; Figure 1 depicts the MSU0500 and MSU0501. Capacities of each subsystem relative to the Mass Storage Processor to which it is attached are presented in Table 2.

### MSU0500 Overview

The formatted storage capacity for the MSU0500 is 626 million 9-bit bytes (940 million characters). The peak transfer rate of the device is 1,065,000 9-bit bytes per second (1,597,000 characters per second). The MSU0500 has one access path per spindle and a dual access feature option (MSF0011) is available to provide an additional non-simultaneous access path, providing a path to each device adapter. This option is required when configuring dual channel subsystems.

The MSU0500 units connect to and are controlled by the MSP0602/0603/0605 Mass Storage Processors. They can also be connected to the MSP8000/8001 and MSP0604/0607/0608/0609 Mass Storage Processors. A description of the Mass Storage Processors and diagrams of MSU0500 attachment can be referenced later in this manual. The MSU0500 can be intermixed with the MSU0400/0402/0451 as shown in the diagrams.

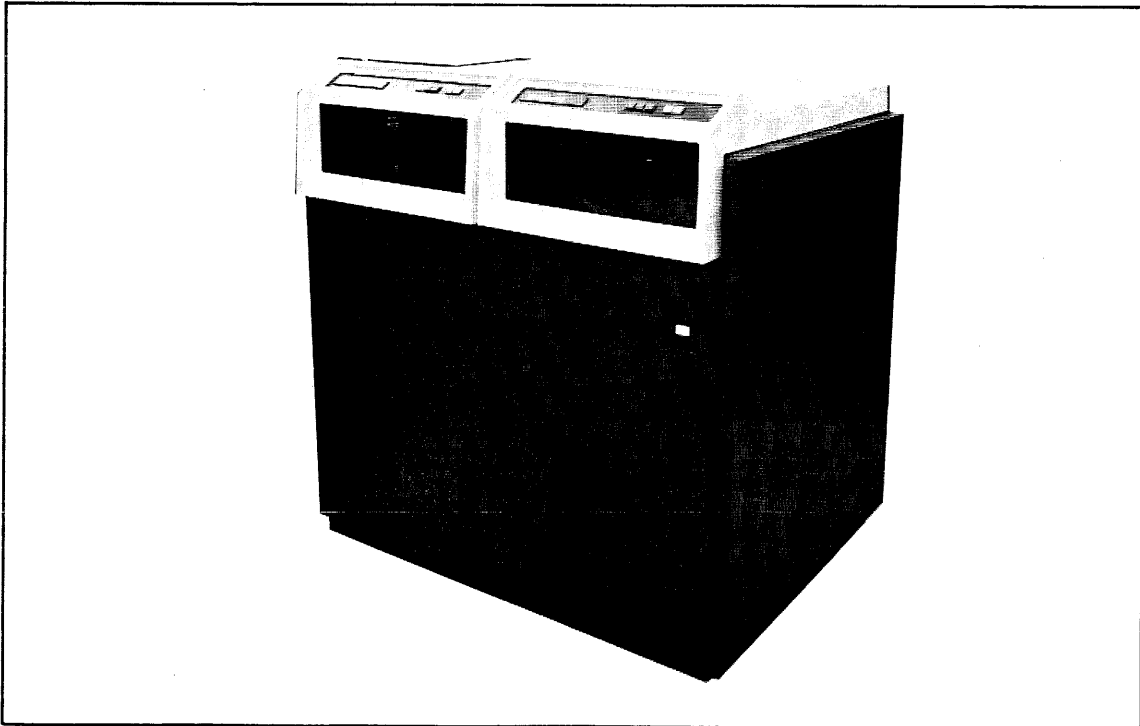

Figure 1. MSU0500/0501 Mass Storage Unit

## MSU0501 Overview

The formatted storage capacity for the MSU0501 is 1101 million 9-bit bytes (1651.5 million characters). The peak transfer rate of the device is 1,065,000 9-bit bytes per second (1,597,000 characters per second). Effective transfer rate is 983,040 9-bit bytes per second (1,474,560 characters per second). The MSU0501 responds to a request device type command with its own unique identification number. Therefore, it can be mixed with 64-word sector devices, i.e., MSU0451 and MSU0500. The MSU0501 has one access path per spindle, and a dual access feature option (MSF0011) is available to provide an additional non-simultaneous access path, providing a path to each device adapter. This option is required when configuring dual channel subsystems. Refer to the Mass Storage Processor description and diagrams later in this manual.

The MSU0501 units can connect to and are controlled by the MSP8000/8001, MSP0604/0607/0608/0609 Mass Storage Processors, described later in this manual. The MSU0501 units can also connect to MSP0602/0603 or 0605 Mass Storage Processors with the appropriate MSU0501 Attachment Feature, MSF1046 (for MSP0605 attachment) or MSF1045 (for MSP0602/3 attachment).

**TABLE 1. MASS STORAGE UNIT CHARACTERISTICS**

Characteristic	MSU0500	MSU0501
<b>FORMATTED CAPACITY:<sup>a</sup></b>		
(Per Dual-Spindle Unit)		
Characters	940 million	1,651 million
9-bit bytes	626 million	1,101 million
<b>TRANSFER RATE:</b>		
	Peak	Effective
Characters per second	1,597,000	921,600
9-bit bytes per second	1,065,000	614,400
<b>ACCESS TIMES (milliseconds):</b>		
Minimum Seek Time	←————— 10 —————→	
Average Seek Time	←————— 25 —————→	
Maximum Seek Time	←————— 50 —————→	
Average Latency	←————— 8.3 —————→	
<b>DISK MODULES (two non-operator removable modules per MSU0500/0501):</b>		
	←————— Included —————→	
Number of spindles	←————— 2 —————→	
Number of disks	←————— 12 —————→	
Recording Surfaces	19	20
Tracks/recording surface	1630	1680
Rotational speed (RPM)	←————— 3600 —————→	
<b>SIMULTANEITY:</b>	During data transfer on one spindle, a simultaneous seek operation can be performed on all other spindles attached to the same control.	
<b>PHYSICAL CHARACTERISTICS:</b>		
Height	44.4 in. (112.7 cm)	
Width	42 in. (106.6 cm)	
Depth	33.3 in. (84.5 cm)	
Weight	1080 lb (489.8 kg)	
<b>ELECTRICAL:</b>		
Power	208 Vac + 10%, -15%, 3 phase	
Power Consumption	2.7 kVA	
Heat Dissipation	7300 Btu/hr	
Frequency	60 Hz ± ½ Hz	
<b>ENVIRONMENT:</b>		
Temperature (operating)	59°F to 90°F (15°C to 32°C)	
Relative Humidity	10% to 80%	

<sup>a</sup>For subsystem capacities, refer to Table 2.

TABLE 2. SUBSYSTEM CAPACITIES

Subsystem	MSU0500	MSU0501
MSP0605 Subsystem	with 4 MSU0500s	with 4 MSU0501s
6-bit Characters (max)	3,760 million	6,606 million
9-bit Bytes (max)	2,504 million	4,404 million
MSP0602/0603 Subsystem	with 8 MSU0500s	with 8 MSU0501s
6-bit Characters (max)	7,520 million	13,212 million
9-bit Bytes (max)	5,008 million	8,808 million
MSP0604/0607 Subsystem	with 8 MSU0500s	with 8 MSU0501s
6-bit Characters (max)	7,520 million	13,212 million
9-bit Bytes (max)	5,008 million	8,808 million
MPS0608/0609 Subsystem	with 15 MSU0500s	with 15 MSU0501s
6-bit Characters (max)	14,100 million	24,772.5 million
9-bit Bytes (max)	9,390 million	16,515 million
MSP8000/8001 Subsystem	with 8 MSU0500s	with 8 MSU0501s
6-bit Characters (max)	7,520 million	13,212 million
9-bit Bytes (max)	5,008 million	8,808 million

## MSU0500/0501 CHARACTERISTICS

### Advanced Data Integrity

The validity of recorded information is ensured by the insertion of check characters used for error detection and correction into each record/sector. Data integrity is enhanced by the automatic detection of defective track areas and the bypassing of these areas when writing to disk.

A write protect capability – standard with this unit – allows the user to protect the two individual disk modules against inadvertent writing.

### Efficient I/O Channel Utilization

More efficient utilization of the I/O channel is achieved through the use of a rotational position sensing feature, which is included with the MSU0500/0501. This feature can be used to reduce the effective latency time of the device. The average seek time is 25 milliseconds.

### System Reliability/Availability

Increased reliability has been achieved by the integration of the read/write heads, actuator arms and disks into a sealed disk module. This improved design increases the reliability and environmental control, minimizing the possibility of disk surface contamination.

Enhanced diagnostic ability reduces both system time required for online repair and the total offline repair time spent on the device itself. Online error and status reporting to the central processor system allow software-controlled diagnosis of the circuitry. In addition, a hardware diagnostic ability allows offline diagnosis and testing.

### Site Efficiency

The MSU0500 and MSU0501 are designed to minimize the floor space required for the subsystem. A typical 4-unit (8-spindle) MSU0500/0501 string occupies less than 160 square feet (14.9 square meters). The 4-unit MSU0500 configuration provides a storage capacity of 3.76 billion characters; while the 4-unit MSU0501 configuration provides a storage capacity of 6.6 billion characters.

## Options

Refer to Table 3 for a list of available options. Refer also to the information in the paragraph entitled "Mass Storage Processors."

TABLE 3. MSU0500/0501 OPTIONS

Device	Option	Description
MSU0500	MSF0500	Additional Head Disk Assembly for MSU0500
MSU0501	MSK0501	Upgrade from MSU0500 to MSU0501
	MSF0501	Additional Head Disk Assembly for MSU0501
	MSK0502	Upgrade from MSF0500 to MSF0501 Head Disk Assembly
	MSF1045 <sup>a</sup>	MSU0501 Attachment Feature on MSP0602/0603 with MSU0500 Device Adapter (MSF1024) installed
	MSF1046 <sup>a</sup>	MSU0501 Attachment Feature on MSP0605 with MSU0500 Device Adapter (MSF1037) installed
	MSF1025 <sup>a</sup>	Device Adapter for MSU0500/0501
MSU0500/0501	MSF1025 <sup>a</sup>	Device Adapter for MSU0500/0501 on MSP0602/0603
	MSF0011	Dual Access Feature

<sup>a</sup>Refer to Table 5 and to the paragraph entitled "MSP0602/0603/0605" later in this manual.

## CONTROLS AND INDICATORS

Table 4 lists and describes the various controls and indicators for each MSU0500/0501 unit, while Figure 2 shows the spindle control panel. The text that follows describes the operating procedures for the unit.

### Device Numbering

Each spindle control panel has a recessed area (see Figure 2) for the application of spindle identification numbers.

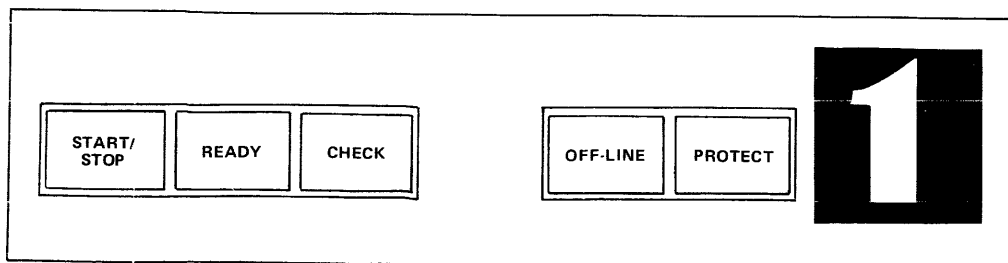

Figure 2. MSU0500/0501 Spindle Control Panel

**TABLE 4. MSU0500/0501 CONTROLS AND INDICATORS**

<b>Control</b>	<b>Description</b>
POWER ON (Push Button/Indicator)	Used to energize and remove power supplies in the unit. Located outside the front door of the right-hand spindle cabinet. Lights when power supplies are energized, and extinguishes when power is removed.
NOTE: The following controls and indicators are located on the operator's control of each spindle's cabinet (see Figure 2).	
START/STOP (Push Button/Indicator)	Used to start or stop spindle rotation. When lighted, it indicates that power is applied to the spindle motor. If pressed when lighted, it causes the spindle to come to a stop and the indicator light goes out.
READY (Indicator)	Lights when the spindle is rotating at the proper speed, the heads are loaded, and the spindle is ready to accept commands.
CHECK (Push Button/Indicator)	Lights when a fault condition has occurred. In general, the indicator will be cleared by programs that analyze fault conditions. Occasionally, these programs will require the operator to correct the problem, then press the button to clear the fault registers and reset the indicator.
OFF-LINE (Indicator)	Lights when the spindle is in the offline mode. A spindle may be placed offline by setting the OFF-LINE switch on the maintenance panel which is accessed by opening both rear doors.
PROTECT (Push Button/Indicator)	Used to inhibit or enable write operations on the disk module. When the PROTECT indicator is lighted, pressing it will turn the light off and enable write operations. When the PROTECT indicator is off, pressing it will turn it on and inhibit write operations.

## **OPERATING PROCEDURES**

### **Power-Up Sequence**

In the following procedure, it is assumed that all cables have been properly connected and secured, and that power is supplied to the unit.

Press the POWER ON button located on the front of the right-hand spindle cabinet of each unit. The POWER ON indicator will light. If the indicator fails to illuminate (indicating that power has not been applied to the unit), contact your local Honeywell field service representative.

### **Power-Down Sequence**

1. Press the START/STOP button located on each spindle control panel. START/STOP and READY indicators will extinguish.
2. Press the POWER ON switch. The indicator will extinguish.

### **Initialization**

To initialize a spindle, press the CHECK button. This resets all device operational and status registers for that spindle.



## Startup Sequence

In the following procedure, it is assumed that the Power-Up and Initialization procedures have been successfully completed.

1. Select appropriate permit/protect mode for each spindle via the PROTECT button.
2. Press START/STOP button on each spindle control panel. START/STOP indicators will light and after a few seconds the READY indicators will light.
3. The MSU0500/0501 is ready to accept commands when READY lights.

## OPERATOR MAINTENANCE

The only operator maintenance required is that of general cleaning.

### General Cleaning

Operators should keep cabinets clear and free of dust.

## MASS STORAGE PROCESSORS

The mass storage processors for the MSU0500 and MSU0501 are microprogrammed peripheral processors that connect to the central processor via high-speed I/O channels and relieve the central processor of all device-oriented functions.

### Components

Each mass storage processor consists of the following components (also see Figure 3):

- o *Read-Only Memory* – provides access and storage to resident control and diagnostic microprograms.
- o *Microprocessor* – interprets all the microinstructions and performs their specified operations.
- o *Scratch-Pad Memory* – provides temporary storage for data buffering parameters and command storage.
- o *Peripheral Subsystem Interface Control* – provides the logic and buffering necessary to interface with the one-byte-wide PSI to sustain data transfer and control dialogs.
- o *Device Level Interface Control* – provides the logic and buffering necessary to interface with DLIs to sustain data transfer and control dialogs in addition to verification information generation and checking.

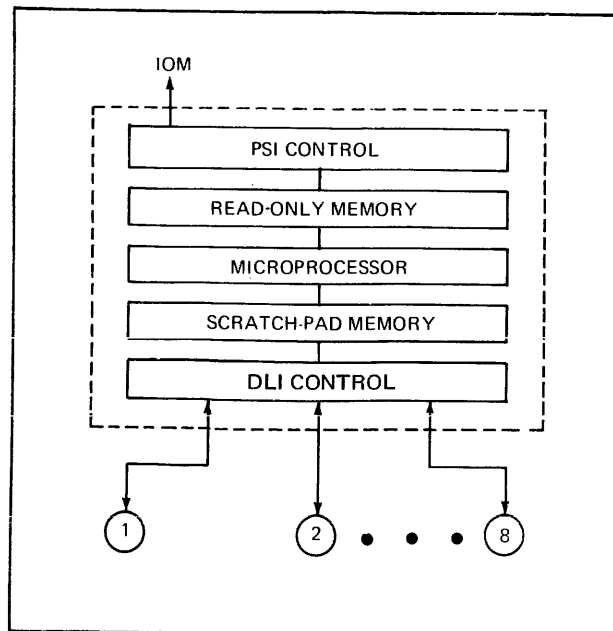

Figure 3. Mass Storage Processor Components

## Options

Refer to Table 5 for a list of Mass Storage Processor options. These options will be referenced in the individual processor discussions that follow.

**TABLE 5. MASS STORAGE PROCESSOR OPTIONS**

Mass Storage Processor	Option	Description
MSP0602/0603	MSF1024	Device Adapter for MSU0500
	MSF1025	Device Adapter for MSU0501/0500 When no MSU500s are present on a MSP0602/0603, the MSF1025 Device Adapter must be ordered to configure MSU0501s, or MSU0500s and MSU0501s in combination. If only MSU0500 is configured, order MSF1024.
	MSF1033	Drive Expansion for more than 16 MSU0400/0402/0451 single channel units
	MSF1035	Device Adapter for MSU0400/0402/0451
	MSF1036	Dual Processor Crossbar (one per two processors)
	MSF1045	MSU0501 Attachment Feature on MSP0602/0603 with MSU0500 Device Adapter MSF1024 installed
	MSF1028	Dual Simultaneous Channel used when no MSU0500/0501s are configured
	MSP0602/0603/0605	MSF1019
MSF1026		Nonsimultaneous IOM Channel used when MSU0500/0501s are configured
MSF1027		Nonsimultaneous DATANET Channel used when MSU0500/0501s are configured
MSA1027		Addressing Capability for four (4) MSU0400/0402/0451 units
MSP0605	MSA1029	Addressing Capability for two (2) MSU0500/0501 units
	MSF1037	Device Adapter for MSU0500
	MSF1038	Device Adapter for MSU0400/0402/0451
MSP0604/0607	MSF1046	MSU0501 Attachment Feature on MSP0605 with Device Adapter MSF1037 installed
	MSK6005	Upgrade Kit (from MSP0605 to MSP0602)
MSP0604/0607	MSF1040	Device Adapter for MSU0400/0402/0451 on MSP0607 only
	MSF1047	Device Adapter for MSU0400/0402/0451 on MSP0604 only
	MSK6006	Upgrade Kit, MSP0604 to an MSP0608
	MSK6007	Upgrade Kit, MSP0607 to an MSP0609
	MSA1040	Addressing Capability for four MSU0400/0402/0451s for MSP0604/0607 only
	MSA1041	Addressing Capability for two MSU0500/0501s for MSP0604/0607 only
MSP0604/0607/0608/0609	MSF1043	Nonsimultaneous (switched) DATANET Channel for MSP0604/0607/0608/0609
	MSF1044	Nonsimultaneous (switched) IOM Channel for MSP0604/0607/0608/0609
MSP0608/0609	MSA1042	Addressing Capability for MSU0400/0402/0451 (one per four MSUs)
	MSA1043	Addressing Capability for MSU0500/0501 (one per two MSUs)

TABLE 5 (CONT). MASS STORAGE PROCESSOR OPTIONS

Mass Storage Processor	Option	Description
MSP8000	MSF1041	Device Adapter for Attachment of up to 16 MSU0400/0402/0451s for the MSP0609 only
	MSF1042	Drive Expansion for up to 7 additional MSU0500/0501s for the MSP0608/0609
	MSF1048	Device Adapter for attachment of MSU0400/0402/0451s for the MSP0608 only
	MSF8000	Device Adapter for MSU0400/0402/0451, limit of 16 drives
	MSA8000	Addressing Capability for four MSU0400/0402/0451s
	MSA8001	Addressing Capability for two MSU0500/0501s
	MSK8000	Upgrade Kit, MSP8000 to MSP8001 (must replace MSF and MSAs with MSP8001 features)
MSP8001	MSF8001	Device Adapter for attachment of up to 16 MSU0400/0402/0451s
	MSA8002	Addressing Capability for four MSU0400/0402/0451s
	MSA8003	Addressing Capability for two MSU0500/0501s
MSP8000/8001	MSF8002	Nonsimultaneous DATANET Channel
	MSF8003	Nonsimultaneous IOM Channel

**MSP0602/0603/0605**

The MSP0602 and MSP0605 are integrated processors located in the integrated control unit (ICU); the MSP0603 is a freestanding processor.

The MSP0602/0603/0605 can be configured with single channels and nonsimultaneous switched channels. Any two of the processors can be crossbarred to provide dual simultaneous access to any two disk units. A dual simultaneous channel on one processor is not possible due to the high transfer rate of the MSU0500/0501.

In multiple system configurations the mass storage subsystem can be expanded to two processors to provide four channel connectability plus four nonsimultaneous channels. Any system will have access to any of the disk units within the subsystem.

**MSU0500/0501 Attachment**

The MSP0602/0603 supports one of the following MSU0500/0501 configurations (see Figures 4 and 5).

- o Up to 8 MSU0500/0501 units (16 spindles)
- o Up to 8 MSU0500/0501 units (16 spindles) and up to 16 MSU0400/0402/0451 units

The MSP0605 supports one of the following configurations (see Figure 6).

- o Up to 4 MSU0500/0501 units (8 spindles)
- o Up to 3 MSU0500/0501 units (6 spindles) and up to 2 MSU0400/0402/0451 units
- o Up to 2 MSU0500/0501 units (4 spindles) and up to 4 MSU0400/0402/0451 units
- o Up to 1 MSU0500/0501 unit (2 spindles) and up to 6 MSU0400/0402/0451 units

**NOTES:**

1. When no MSU0500s are present on the MSU0602/0603 (Feature MSF1024 Device Adapter is not installed), the MSF1025 Device Adapter must be ordered when configuring the MSU0501.
2. When the MSF1024 Device Adapter is installed on the MSP0602/0603 (i.e., MSU0500 installed), the MSF1045 Attachment Feature is required for MSU0501 attachment.

3. When the MSF1037 Device Adapter is installed on the MSP0605, the MSF1046 Attachment Feature must be ordered for MSU0501 attachment.
4. When no MSU0500 units are present on the MSP0605, the MSF1037 Device Adapter and the MSF1046 Attachment Feature must be ordered for MSU0501 attachment.
5. The MSU0500 may be upgraded to the MSU0501 via the MSK0501 Upgrade Option. Also, the MSK0502 upgrades the MSF0500 Additional Head Disk Assembly to the MSF0501 Additional Head Disk Assembly.

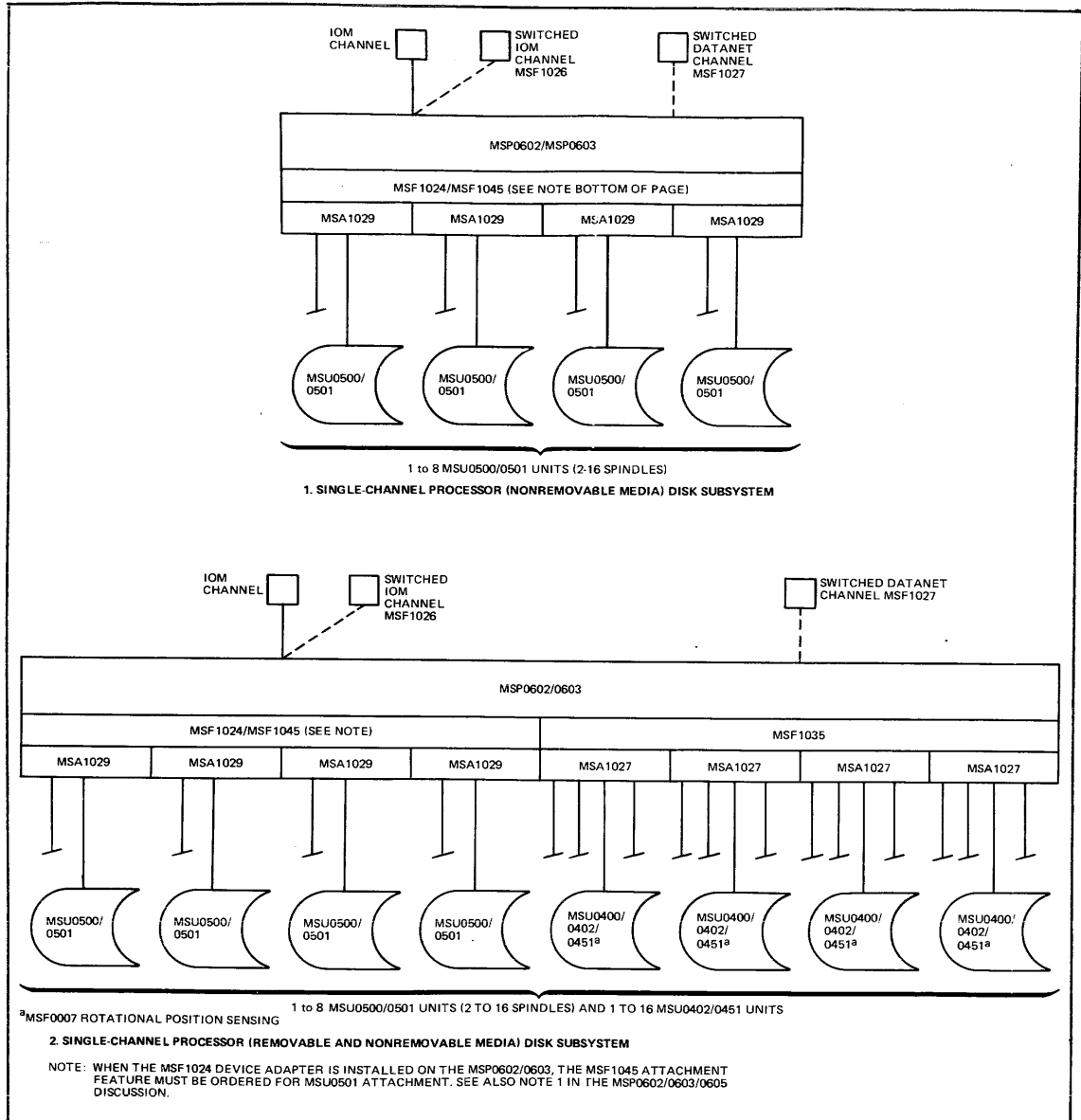

**Figure 4. MSP0602/0603 Single-Channel Configurations**

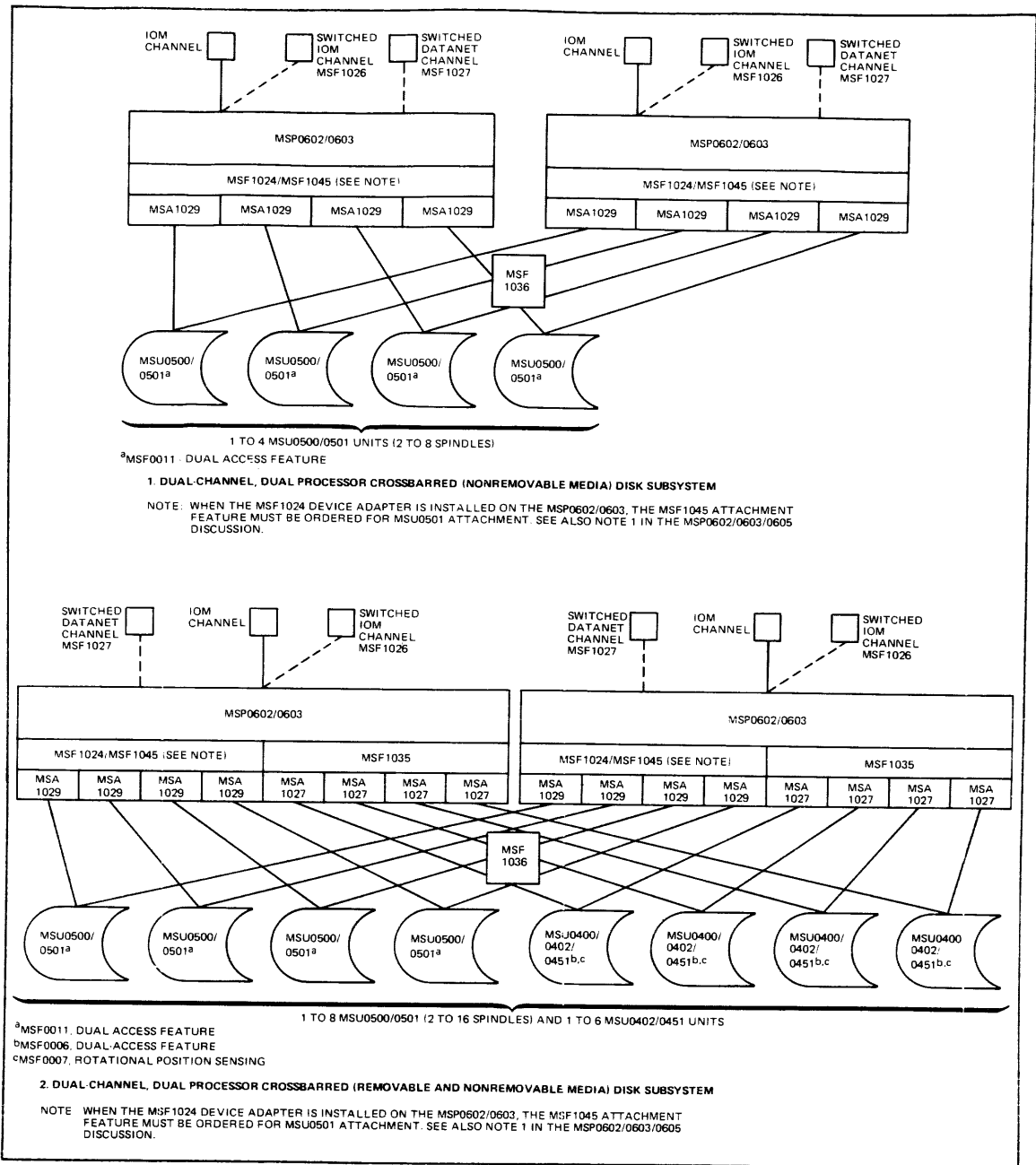
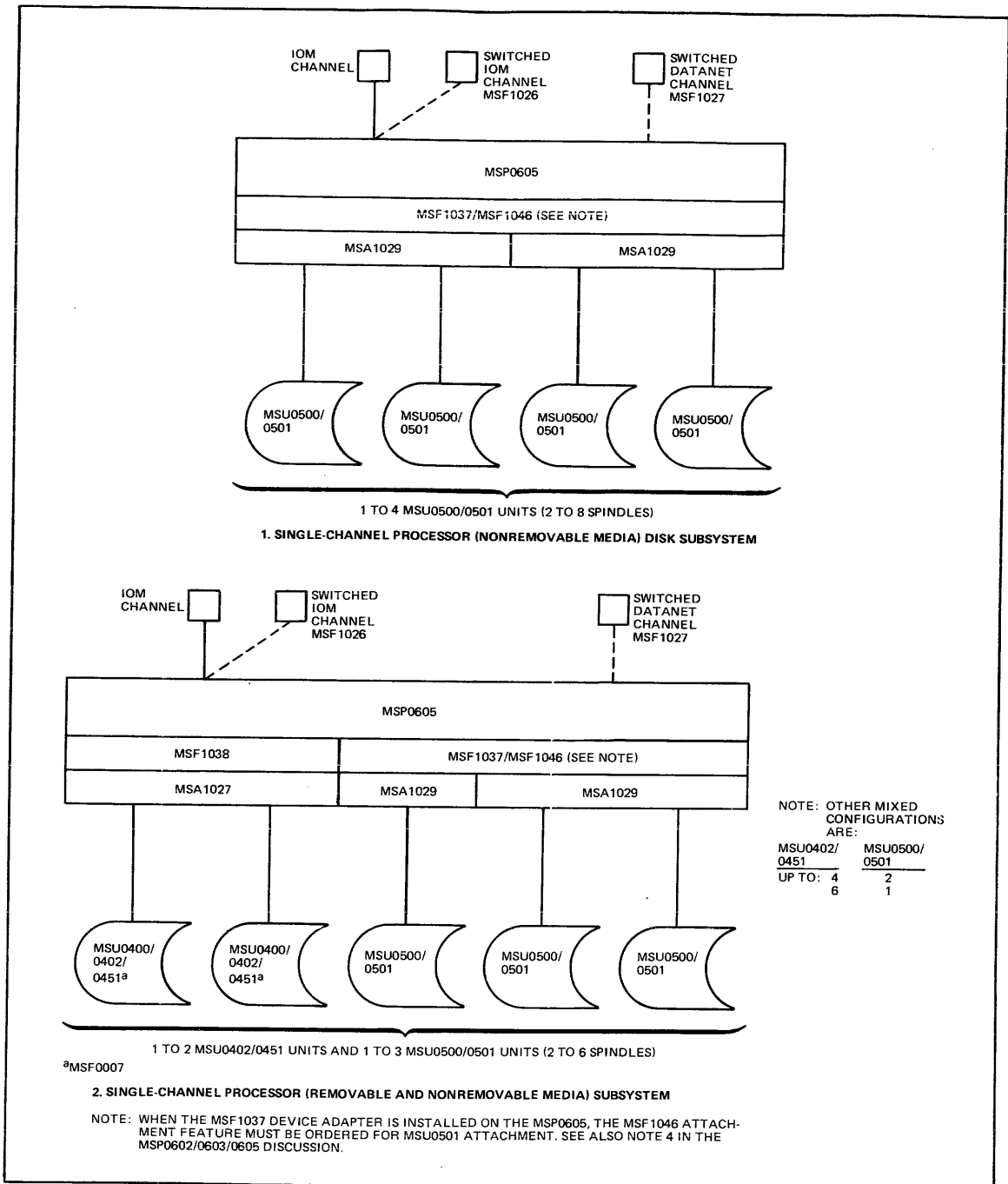

Figure 5. MSP0602/0603 Dual-Channel Configurations



**Figure 6. MSP0605 Configurations**

### MSP0604/0607/0608/0609

The following mass storage processors are available for the DPS 8, Level 66/DPS and Level 68/DPS. Following the list is a description of the processors and the connectivity requirements for the MSU0500/0501.

- o MSP0604 – Single channel (integrated) Mass Storage Processor for DPS ICU systems only
- o MSP0607 – Single channel (freestanding) Mass Storage Processor for DPS systems only
- o MSP0608 – Dual channel (integrated) Mass Storage Processor for DPS ICU systems only
- o MSP0609 – Dual channel (freestanding) Mass Storage Processor for all DPS systems only

Upgrade Capabilities:

- o MSK6006 – Upgrade, MSP0604 to MSP0608
- o MSK6007 – Upgrade, MSP0607 to MSP0609

The MSP0604 is physically located within the central processing system integrated control unit while the MSP0607 is a freestanding unit. Both will support up to a maximum of eight (8) MSU0500/0501 devices or a maximum of sixteen (16) MSU0400/0402/0451 devices. Any combination of these drives will be supported up to a maximum of sixteen (16) spindles.

The MSU0500/0501 device adapter is integrated with the controller and need not be ordered separately.

There is an upgrade kit for each of the single channel controllers, MSP0604 to MSP0608 and MSP0607 to MSP0609. When ordering these upgrade kits, the addressing features MSA1040/41 must be replaced by MSA1042/43 where used.

One channel of the MSP0608 is integrated into the integrated control unit of the central processing system while the second channel is freestanding. The MSP0609 is totally free-standing.

Either of these controllers will support up to 15 MSU0500/0501 devices (30 spindles) or 16 MSU0400/0402/0451 devices can also be supported.

As with the MSP0604/0607, the MSU0500/0501 device adapter is included and can support up to eight (8) devices (16 spindles). When expanding to support up to 15 MSU0500/0501 devices (30 spindles) or when supporting MSU0400/0402/0451s the appropriate device expansion/device adapter is required.

Refer to Table 5 for a list of the options; Figures 7 and 8 illustrate examples of MSU0500/0501 attachment.

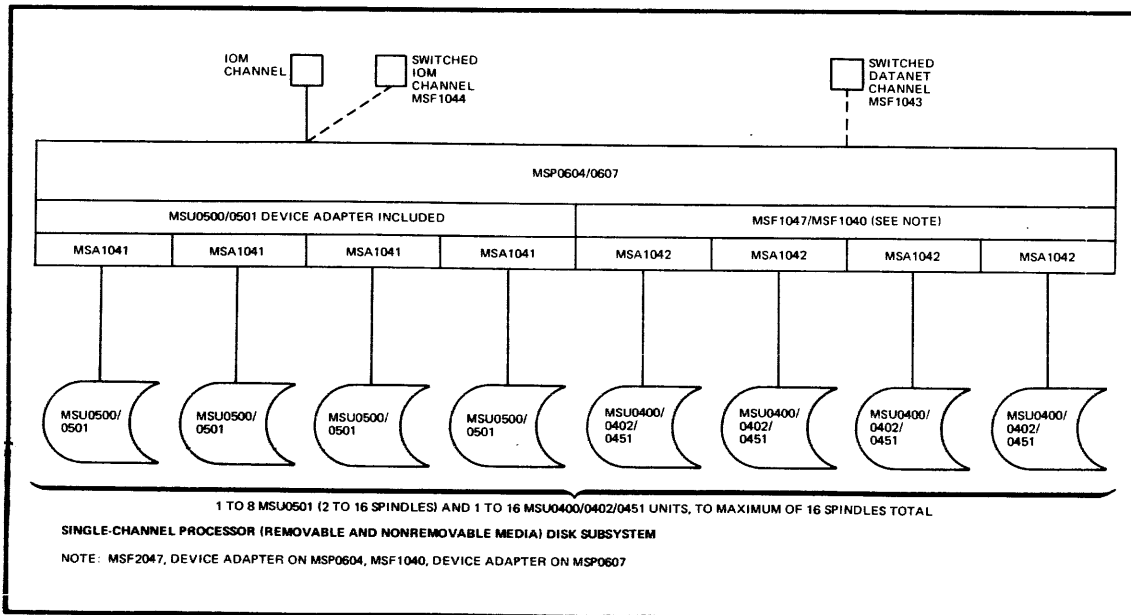

Figure 7. MSP0604/0607 Configuration

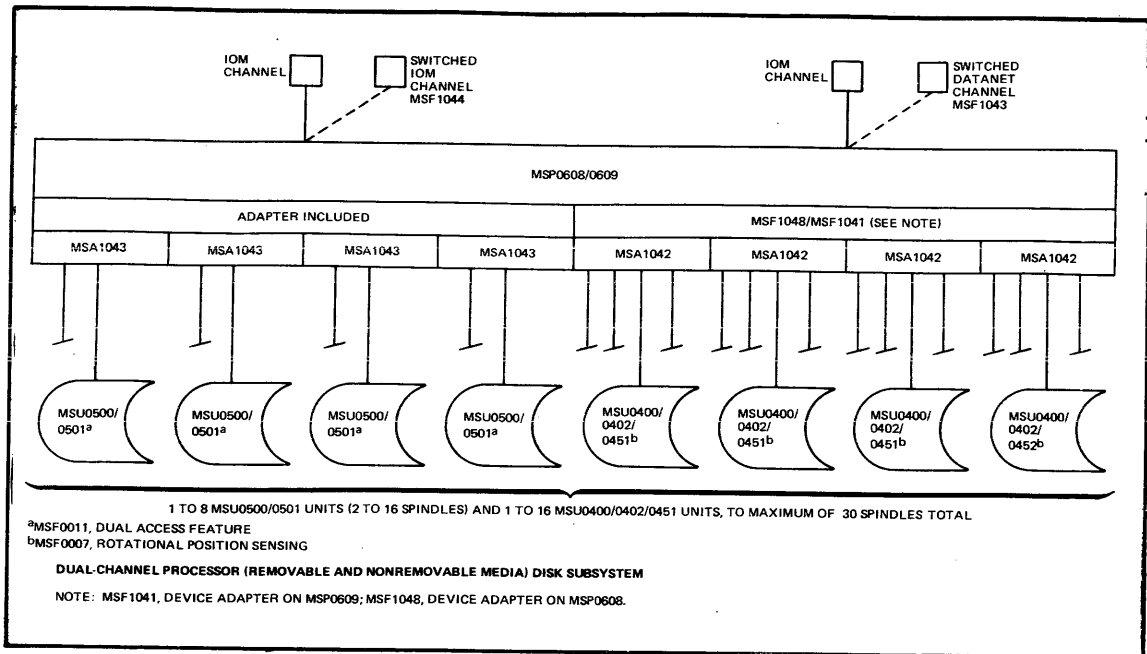

Figure 8. MSP0608/0609 Configuration

### MSP8000/8001

The MSP8000 is a single channel microprogrammable mass storage processor physically located within the DPS 8/20 or DPS 8/44 central system. The MSP8001 is a dual channel microprogrammable mass storage processor. One channel of the MSP8001 is integrated into the DPS 8/20 or DPS 8/44 while the second channel is freestanding.

Both the MSP8000 and MSP8001 will support up to a maximum of eight (8) MSU0500/0501 devices. The processors also support a maximum of sixteen (16) MSU0400/0402/0451.

The MSU0500/0501 device adapter is included as an integral feature of the MSP8000/8001. There is also an upgrade kit to upgrade the MSP8000 to MSP8001.

Refer to Table 5 for a list of MSP8000/8001 options, and to Figures 9 and 10 for examples of MSU0500/0501 attachment to the MSP8000 and MSP8001, respectively.

### Controls and Indicators

The operator control panel, located on the top of the Mass Storage Processor for freestanding units or in the Integrated Control Unit for integrated versions,<sup>1</sup> contains the controls and indicators required for normal operation of the MSP. Refer to Figures 11 and 12, respectively. A description of each pushbutton/indicator is given in Table 6.

<sup>1</sup> Refer to the introductory paragraph under the heading "Mass Storage Processors" earlier in the manual for a definition of freestanding and integrated devices.



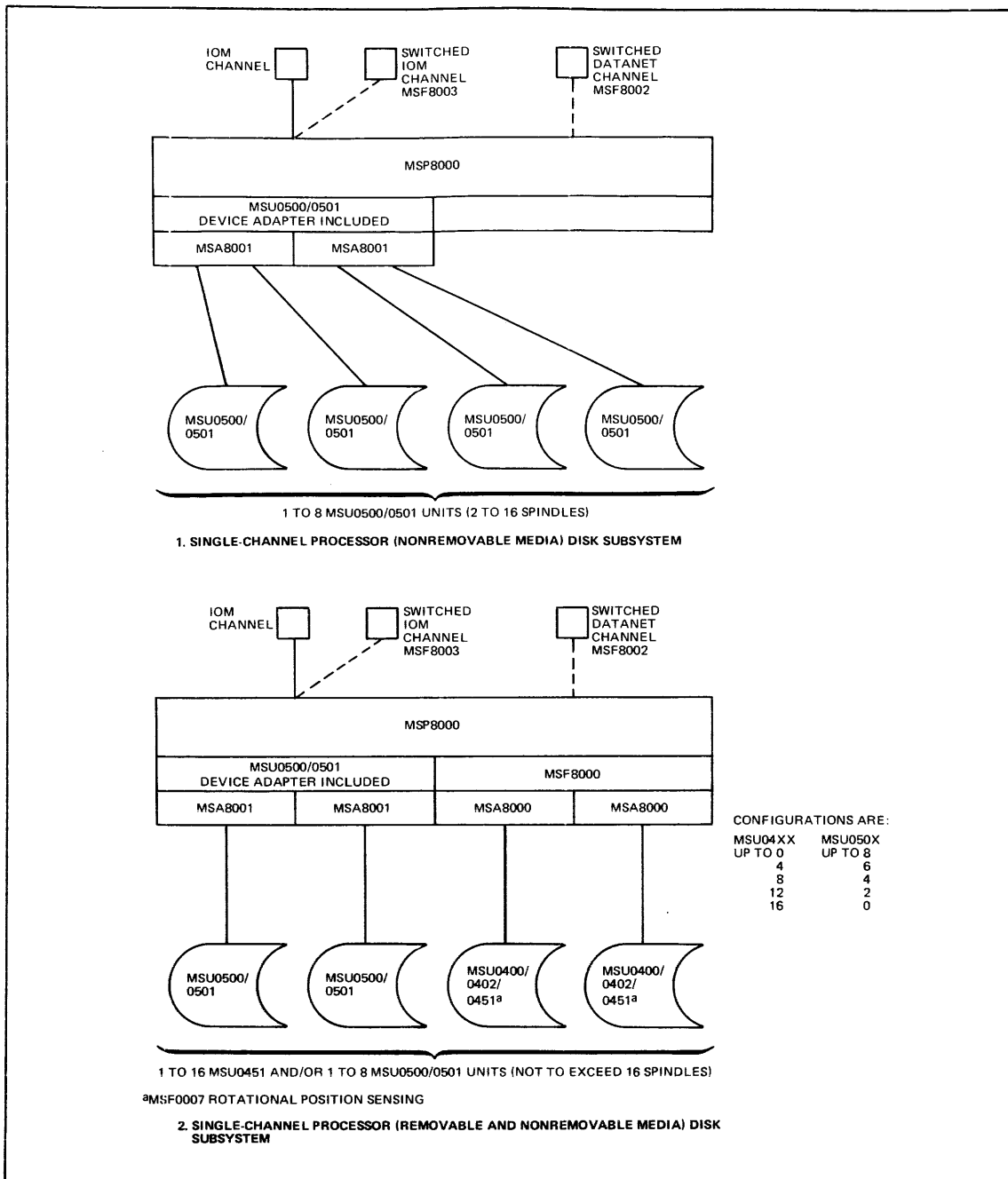

**Figure 9. MSP8000 Configurations**

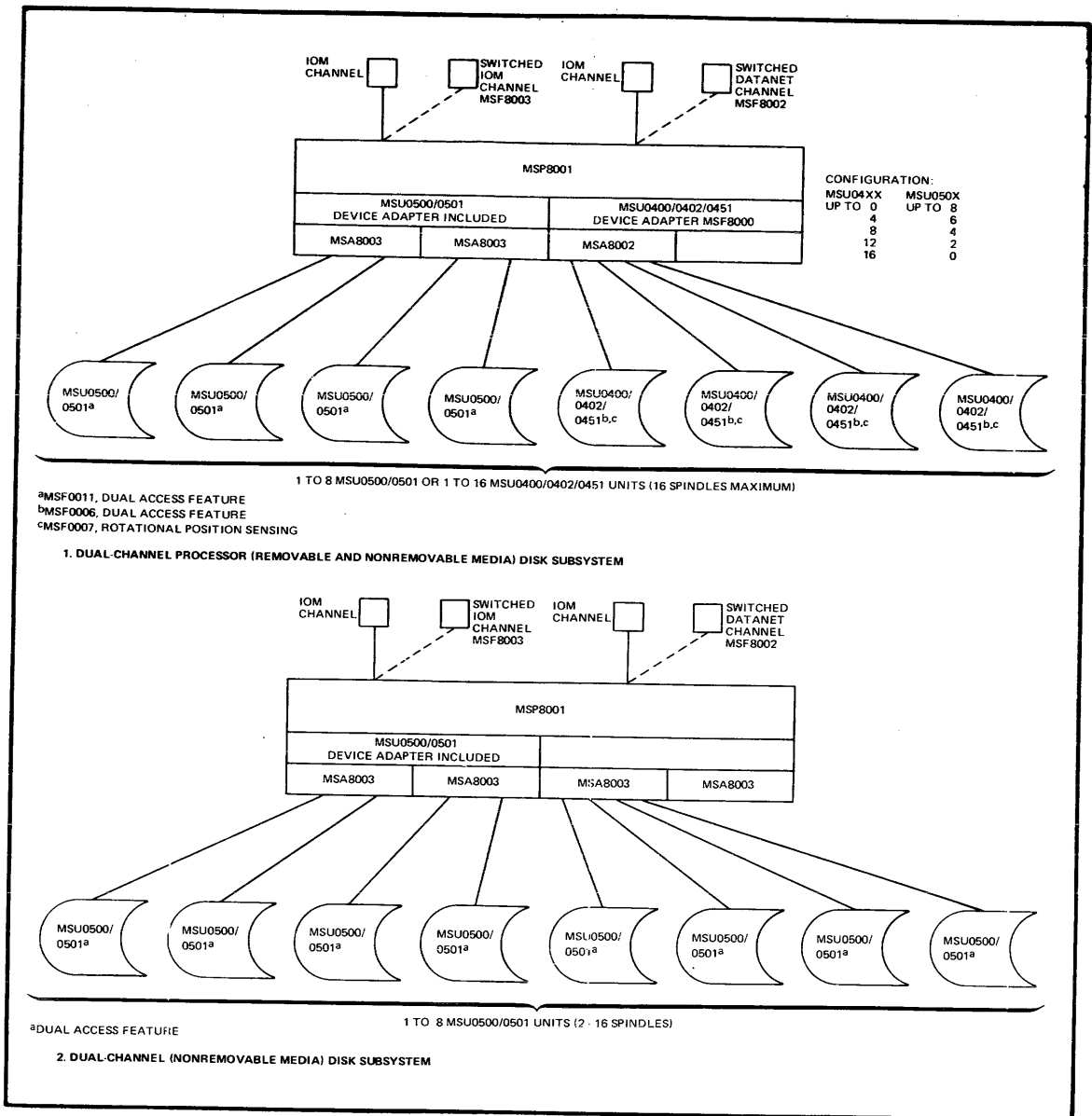

Figure 10. MSP8001 Configurations

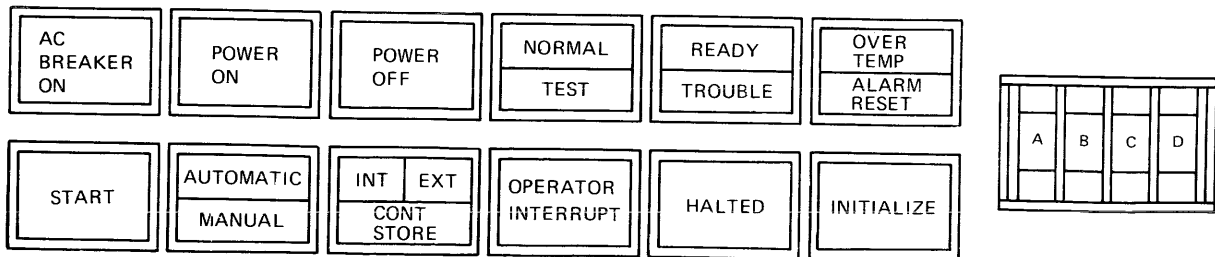

Figure 11. Freestanding Mass Storage Processor Control Panel

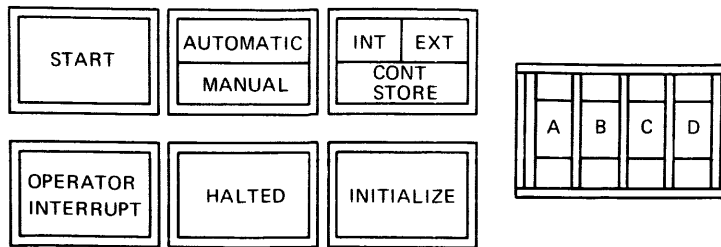
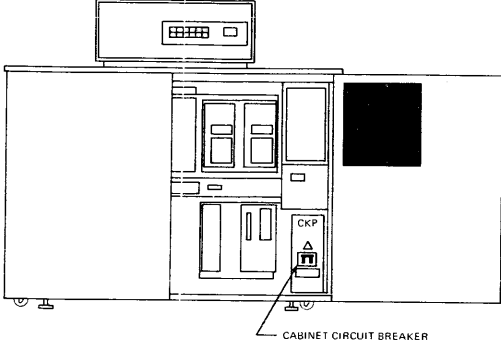

Figure 12. Integrated Mass Storage Processor Control Panel

TABLE 6. MASS STORAGE PROCESSOR CONTROLS AND INDICATORS

Push Button/Indicator	Function
All Processors	
START	Pressing this button when the control/processor is in the HALTED state changes it from the TROUBLE state to the READY state (see READY/TROUBLE indicator) and the indicator lights white.
AUTOMATIC/MANUAL	This split-field indicator identifies the operational mode (green = AUTOMATIC, blue = MANUAL) of the control/processor. The button allows the operator to control the execution of the initialize and halt options of the microprogram. These options are logically enabled in the MANUAL mode. Pressing this button changes the state of the switch.
INT/EXT/CONT STORE	This three-way split-field indicator lights red in the individual field when an error is detected. Pressing this button or executing the microprogram's error option should reset the error and turn off the indicator light. If the error persists, notify the Honeywell field engineer. EXT – Indicates an error detected during a device adapter interface or main memory operation. INT – Indicates an error detected internal to the processing structure of the processor (internal buses, etc.) STORE – Indicates an error detected during the access of a microprogram from processor store.
OPERATOR INTERRUPT	Pressing this button lights the indicator white and causes the execution of a special interrupt that transfers the information stored in the ADDRESS/SIMULATE switches to the central system. The OPERATOR INTERRUPT state is reset by the microprogram and the indicator goes out.
HALTED	This indicator lights blue when the control/processor goes into the halted state.
INITIALIZE	Pressing this button lights the HALTED indicator and resets the control/processor to the initialized state. The indicator lights white.
ADDRESS SIMULATE	These four thumbwheel switches, used in conjunction with the maintenance panel switches permit the user to address various functions of the control/processor, depending upon the specific application required. These switches are used mainly by the field engineer in conjunction with the maintenance panel to diagnose the control/processor. Do not change the state of these switches while they are being sensed by the microprogram.

TABLE 6 (CONT). MASS STORAGE PROCESSOR CONTROLS AND INDICATORS

Push Button/Indicator	Function
<p>The remaining indicators/push buttons are for the freestanding processors only.</p>	
AC BREAKER ON	<p>This indicator lights red when the cabinet circuit breaker is on and power is being applied to it from its power source panel.</p> <p>NOTE: The cabinet circuit breaker is located behind the right front door at the bottom right side of the cabinet on the CKP panel. This circuit breaker applies primary service power to the cabinet and protects it from overloads.</p>
 <p>The diagram shows a front view of a cabinet with a control panel on the left and a door on the right. A callout box labeled 'CKP' points to a panel on the right door, which is identified as the 'CABINET CIRCUIT BREAKER'.</p>	
POWER ON	<p>Pressing this button when ac power is on (AC BREAKER ON indicator lit) turns the cabinet dc power on. The POWER ON indicator lights yellow and the POWER OFF indicator goes out.</p>
POWER OFF	<p>Pressing this button when dc power is on turns the dc power off. The POWER OFF indicator lights green and the POWER ON indicator goes out.</p>
NORMAL TEST	<p>This split-field indicator identifies the state (green = NORMAL, yellow = TEST) of the MAINT PANEL MODE NORMAL/TEST switch located on the TEST area of the maintenance panel. The switch must be in the NORMAL state for online operation.</p> <p>NOTE: The maintenance panel is concealed behind the cover surrounding the operator panel. If the switch is in the TEST position, the operator may open the cover and reset the switch to NORMAL.</p>
READY/TROUBLE	<p>This split-field indicator identifies the operational state (green = READY, red = TROUBLE) of the control/processor.</p> <p>NOTE: The trouble state exists when the HALTED indicator is on or when the OPERATIONAL MODE OFFLINE/ONLINE switch located on the TEST area of the maintenance panel is set to OFFLINE. If the HALTED indicator is on, the operator may attempt to set the control/processor to the READY state by using the START switch. If it does not leave the HALTED state, open the maintenance panel cover and check and reset the OFFLINE/ONLINE switch to ONLINE if needed. If the trouble persists, the operator should notify the local Honeywell field engineer.</p>
OVER TEMP/ ALARM RESET	<p>This split-field push button/indicator lights red in the OVER TEMP field and white in the ALARM RESET field. The cabinet audible alarm sounds if the cabinet gets too warm. Pressing the switch turns off both the audible alarm and the white ALARM RESET indicator. The operator should press the POWER OFF switch and wait for the cabinet to cool before switching power back on. If the overtemperature condition continues, notify the local Honeywell field engineer.</p>

HONEYWELL INFORMATION SYSTEMS  
Technical Publications Remarks Form

CUT ALONG LINE

TITLE

LEVELS 66, 68, AND DPS 8  
MSU0500/0501 MASS STORAGE UNIT OPERATION

ORDER NO.

AY03, REV. 1

DATED

DECEMBER 1979

ERRORS IN PUBLICATION

[Empty box for errors in publication]

SUGGESTIONS FOR IMPROVEMENT TO PUBLICATION

[Empty box for suggestions for improvement to publication]



Your comments will be investigated by appropriate technical personnel and action will be taken as required. Receipt of all forms will be acknowledged; however, if you require a detailed reply, check here.

FROM: NAME \_\_\_\_\_

DATE \_\_\_\_\_

TITLE \_\_\_\_\_

COMPANY \_\_\_\_\_

ADDRESS \_\_\_\_\_

\_\_\_\_\_

PLEASE FOLD AND TAPE—  
NOTE: U. S. Postal Service will not deliver stapled forms



NO POSTAGE  
NECESSARY  
IF MAILED  
IN THE  
UNITED STATES

**BUSINESS REPLY MAIL**  
FIRST CLASS PERMIT NO. 39531 WALTHAM, MA02154

POSTAGE WILL BE PAID BY ADDRESSEE

**HONEYWELL INFORMATION SYSTEMS**  
200 SMITH STREET  
WALTHAM, MA 02154

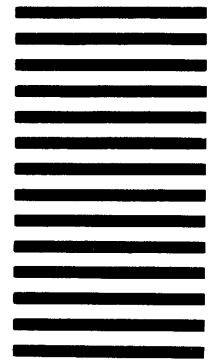

ATTN: PUBLICATIONS, MS486

**Honeywell**

CUT ALONG LINE  
FOLD ALONG LINE  
FOLD ALONG LINE

# Honeywell

## **Honeywell Information Systems**

In the U.S.A.: 200 Smith Street, MS 486, Waltham, Massachusetts 02154  
In Canada: 2025 Sheppard Avenue East, Willowdale, Ontario M2J 1W5  
In the U.K.: Great West Road, Brentford, Middlesex TW8 9DH  
In Australia: 124 Walker Street, North Sydney, N.S.W. 2060  
In Mexico: Avenida Nuevo Leon 250, Mexico 11, D.F.